

FILED

UNITED STATES DISTRICT COURT
ALBUQUERQUE, NEW MEXICO

**UNITED STATES DISTRICT COURT
DISTRICT OF NEW MEXICO**

FEB 21 2012

United States of America
and State of New Mexico,

Plaintiffs,

v.

Freeport-McMoRan Corporation;
Freeport-McMoRan Chino Mines Company;
Freeport-McMoRan Tyrone Inc.;
Freeport-McMoRan Tyrone Mining LLC; and
Freeport-McMoRan Cobre Mining Company,

Defendants.

Case No. 2:11-cv-01140-~~110~~
MATTHEW J. DYKMAN
CLERK

Judge James A. Parker

Mag. Judge Gregory B. Wormuth

ORDER

Before this Court is the Plaintiffs' Unopposed Motion to Enter Consent Decree (ECF Doc. 10) and the proposed Consent Decree (ECF Doc. 2-1). For good cause shown, the Court determines that the Consent Decree should be signed and entered.

IT IS ORDERED that the motion is GRANTED. The Court will sign and enter the Consent Decree forthwith.

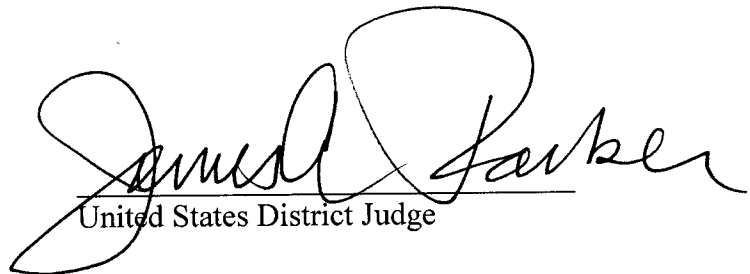
United States District Judge

FILED

UNITED STATES DISTRICT COURT UNITED STATES DISTRICT COURT
DISTRICT OF NEW MEXICO ALBUQUERQUE, NEW MEXICO

FEB 21 2012

United States of America
and State of New Mexico,

Plaintiffs,

v.

Freeport-McMoRan Corporation;
Freeport-McMoRan Chino Mines
Company; Freeport-McMoRan Tyrone
Inc.; Freeport-McMoRan Tyrone Mining
LLC; Freeport-McMoRan Cobre Mining
Company,

Defendants.

MATTHEW J. DYKMAN
CLERK

Civil Action No. 11-1140 JAP/GBW

CONSENT DECREE

Table of Contents

I.	BACKGROUND.....	1
II.	JURISDICTION AND VENUE	12
III.	PARTIES BOUND.....	12
IV.	DEFINITIONS	13
V.	STATEMENT OF PURPOSE	17
VI.	PAYMENT BY THE PERFORMING SETTLING DEFENDANTS.....	17
VII.	FORCE MAJEURE	21
VIII.	TRANSFER OF CERTAIN CITY OF ROCKS AND FAYWOOD CIENEGA RANCH PROPERTY.....	22
IX.	TRUSTEE-SPONSORED NATURAL RESOURCE RESTORATION PROJECTS	23
X.	COVENANTS NOT TO SUE BY THE UNITED STATES AND THE STATE.....	24
XI.	RESERVATION OF RIGHTS BY THE UNITED STATES AND THE STATE	25
XII.	COVENANTS BY SETTLING DEFENDANTS.....	28
XIII.	EFFECT OF SETTLEMENT - CONTRIBUTION PROTECTION	29
XIV.	NOTICES	30
XV.	APPENDICES.....	32
XVI.	EFFECTIVE DATE AND RETENTION OF JURISDICTION.....	32
XVII.	CONSENT DECREE MODIFICATIONS.....	32
XVIII.	LODGING AND OPPORTUNITY FOR PUBLIC COMMENT	33
XIX.	SIGNATORIES / SERVICE	33

XX. FINAL JUDGMENT34

SIGNATURE PAGES

APPENDICES

APPENDIX A: Map generally depicting the Sites and surrounding land in the vicinity

APPENDIX B: Form of deed and a legal description of real property

APPENDIX C: Fencing specifications acceptable to the State

APPENDIX D: Donation Agreement between the State of New Mexico, Energy,
Minerals and Natural Resources Department, State Parks Division
("Grantee"), the New Mexico Natural Resources Trustee ("the Trustee")
and Freeport-McMoRan Chino Mines Company ("Grantor")

This Consent Decree is made and entered into by and among (i) the United States of America (“United States”), on behalf of the United States Department of the Interior (“DOI”); (ii) the State of New Mexico (“State”), acting through the New Mexico Natural Resources Trustee and the New Mexico Office of Natural Resources Trustee (jointly “ONRT”), and the New Mexico Attorney General and the New Mexico Attorney General’s Office (jointly “AGO”); and (iii) Freeport-McMoRan Corporation, Freeport-McMoRan Chino Mines Company, Freeport-McMoRan Tyrone Inc., Freeport-McMoRan Tyrone Mining LLC, and Freeport-McMoRan Cobre Mining Company on behalf of themselves and other settling defendants (the “Settling Defendants”).

I. BACKGROUND

A. The United States on behalf of the Secretary of the DOI, and the State, acting through ONRT and AGO, have filed a Complaint along with this Consent Decree asserting a claim under Section 107 of the Comprehensive Environmental Response, Compensation, and Liability Act of 1980, as amended (“CERCLA”), 42 U.S.C. § 9607. Plaintiffs seek damages for injury to, destruction of, or loss of natural resources belonging to, managed by, or controlled by the United States or the State, resulting from releases of hazardous substances at and from the Chino Mine Site, the Tyrone Mine Site, and the Cobre Mine Site, including the costs of assessing such injury, destruction, or loss.

B. The Complaint filed by Plaintiffs alleges that natural resources, including, but not limited to, surface waters, ground water, terrestrial habitat and terrestrial receptors, and migratory birds, have been injured as a result of releases of hazardous substances at and from the Sites; as a result thereof, the public has suffered the loss of natural resources and associated

services; and Plaintiffs have incurred costs in connection with the assessment of such injuries, destruction or losses.

C. The Complaint further alleges that Performing Settling Defendants (as defined below) are liable for damages for injury to, destruction or loss of natural resources because they are or were owners or operators of one or more facilities from which such releases occurred; or were owners or operators of one or more such facilities at a time hazardous substances were disposed of at such facilities.

D. This Consent Decree addresses claims by the United States for alleged injuries to all Natural Resources as defined in this Agreement, claims by the State for injuries to all Natural Resources other than ground water resources, and claims for Past Costs and Future Costs. Previously and separately from this Consent Decree, the State, without the participation of the United States, filed a Complaint in this Court, Case No. 1:10-cv-01254-RHS –LFG, alleging injuries to ground water resources, and a consent decree was entered to resolve that Complaint, settling all of New Mexico’s claims of injury to ground water. This Consent Decree is not intended to duplicate or cover the matters addressed in Case No. 1:10-cv-01254-RHS–LFG.

E. By entering into this Consent Decree, the State of New Mexico does not concede, agree, or admit that the United States has any interest in surface water or ground water in New Mexico.

F. By entering into this Consent Decree and undertaking the obligations imposed under its terms, Settling Defendants do not expressly, or by implication, make any admissions of liability, including but not limited to liability for injury to, destruction or loss of natural resources

as alleged in the Complaint, and Settling Defendants do not admit any of the allegations of the Complaint, except as expressly stated in this Consent Decree.

G. Chino Mine: The Chino Mine complex is owned and operated by Freeport-McMoRan Chino Mines Company, f/k/a Chino Mines Company, a New Mexico General Partnership. From 1980 to 2003, Heisei Minerals Corporation, a former Delaware corporation, owned a one-third general partnership interest in Chino Mines Company. Mitsubishi Corporation and Mitsubishi Materials Corporation owned 40% and 60%, respectively, of the common stock of Heisei. In 2003, Heisei sold its one-third partnership interest in Chino Mines Company to Chino Acquisition, Inc. and Heisei Minerals Corporation was subsequently dissolved.

1. The Chino Mine Site consists of the Chino Mine and appurtenant area, including the Santa Rita open pit, the Groundhog Mine, the Ivanhoe Concentrator, a former precipitation plant, an operating SX-EW Plant, the former Hurley mill, concentrator, and smelter and associated facilities and units as described below. The mine area of the Chino Mine Site is located near the town of Bayard in T17S, R12W, Sections 25, 26, 27, 28, 29, 32, 33, 34, 35 and 36; and T18S, R12W, Sections 3 and 4. The Santa Rita open pit is approximately 1.8 miles in diameter and 0.3 miles deep (from 6,600 to 5,050 feet elevation) and covers approximately 2,560 acres. Approximately 1,800 million tons of rock from the Santa Rita open pit has been placed in various leach stockpiles and waste rock piles located around the open pit. Mining process water reservoirs located around the perimeter of the open pit cover a combined area of approximately 165 acres, while seepage impoundment and storm water retention reservoirs cover an additional 8 acres. The Groundhog Mine area within the Chino

Mine Site contains underground mine workings and reclaimed waste rock piles.

2. The former Hurley smelter, concentrator and tailings impoundments are located east and south of the town of Hurley in Grant County: T18S, R12W, Sections 31 and 32; T19S, R12W, Sections 5, 6, 7, 8, 16,17, 18, 19, 20, 21, 28, 29, 30, and 33; T20S, R12W, Sections 4, 9, 16, 21, 22, 27, 34, and 35; and T18S, R13W, Sections 12 and 13; and in Luna County: T21S, R12W, Sections 1, 2, and 12; T21S, R11W, Section 7 and 18. A concentrate filter plant, concentrate loading facilities, power generation facilities, a tailings impoundment, and associated pipelines continue to operate in this area. The former smelter area and slag piles cover approximately 195 acres within the described Site. Near Lake One, 230 acres contain sediment from Whitewater Creek, tailings and concentrate associated with the former concentrator and tailings thickeners, and tailings recovered from numerous tailings pipeline spills. The Chino tailings impoundments comprise approximately 690 million tons of tailings and include Axiflo Lake. The Pond 7 seepage interceptor system consists of 18 to 20 wells that pump ground water mixed with tailings pond seepage to the top surface of Pond 7.

3. Open-pit mining at the Chino Mine Site began in 1910. In 1911, a mill and concentrator used to process ore from the Santa Rita open pit was built, and in 1981 the Ivanhoe mill and concentrator were constructed, along with pipelines to transport tailings and concentrate from the mill to the Hurley smelter and the tailings impoundments and to return process water to the concentrator. Tailings from the Chino Mine Site have been deposited in Lake One and in the tailings impoundments east and south of Hurley along the former channel of Whitewater Creek.

4. The Complaint alleges that, once inactive, tailings exposed to air and

precipitation release hazardous substances on the surface of the tailings or that percolate through the tailings to ground water. These substances allegedly include, but are not limited to sulfuric acid and various dissolved metals (depending upon the mineral composition of the tailings) such as arsenic, beryllium, cadmium, chromium, cobalt, copper, lead, manganese, mercury, nickel, selenium, and zinc. The Complaint further alleges that windblown tailings have been deposited off-site according to prevailing wind direction and speed.

5. Leaching operations commenced in 1936 on low-grade ore stockpiles deposited near the Santa Rita open pit. Leaching operations consist of acidic solutions applied to ore stockpiles to leach copper into solution. This “pregnant leach solution” (PLS) was collected in open channels and uncovered ponds and transported to precipitation plants. Any overflows from the leaching operations flowed into Whitewater Creek, the creek channel to Lake One and, occasionally, into Whitewater Creek downgradient of Lake One. The Complaint alleges that PLS in seepage from leach stockpiles, channels and ponds and overflows contained hazardous substances including, but not limited to sulfuric acid and dissolved metals (depending on the mineral composition of the leached ore) including: arsenic, beryllium, cadmium, chromium, cobalt, copper, lead, manganese, mercury, nickel, selenium, and zinc.

6. In 1988, a Solution Extraction/Electrowinning (SX/EW) plant was constructed east of the open pit, and additional ore leaching activities began. The SX/EW plant continues in operation.

7. Construction of a copper smelter near the town of Hurley was completed in 1939 and operated until 2002. The Complaint alleges that natural resources surrounding the smelter have been and continue to be exposed to, and injured by, hazardous substances

previously deposited via prevailing winds from the smelter and the nearby tailings impoundments.

8. Surface flows from the Chino Mine drain into drainages in the Mimbres River watershed. Major drainages at Chino include: Whitewater Creek, Hanover Creek, and Lampbright Draw. The Complaint alleges that these drainages have been contaminated by hazardous substances originating at the Chino Mine facilities.

9. On December 23, 1994, an Administrative Order on Consent (AOC) was signed between the Chino Mines Company and the New Mexico Environment Department that directs a "Superfund-Like" remedial action with respect to historical copper mining and smelter operations at the Chino Mine Site. A remedial investigation for this AOC region is underway. A remedial investigation "Background Report" was completed under the AOC on October 5, 1995, and ecological risk assessment reports have since been issued by the New Mexico Environment Department in accordance with 40 C.F.R. § 300.430. Further investigations and feasibility studies are ongoing, and one Record of Decision has been issued for soil remediation in the Town of Hurley.

H. Tyrone Mine: The Tyrone Mine is operated by Freeport-McMoRan Tyrone Inc., a Delaware corporation, and is owned by Freeport-McMoRan Tyrone Mining LLC, a New Mexico limited liability corporation. The Tyrone Mine Site consists of several open pits, leach ore stockpiles, a former mill and concentrator, a former precipitation plant, an operating Solution Extraction/Electrowinning (SX-EW) plant, the Little Rock Mine, PLS collection impoundments, seepage interception systems, stormwater detention impoundments, a maintenance and lubrication area, process solution pumping stations, former mill and concentrator facilities, a former precipitation plant, an acid unloading facility, and the Burro Mountain

tailings impoundment.

1. The mining area at the Tyrone Mine is located near the Town of Tyrone in Sections 19, 20, 29 and 30 of T19S, R14W; and Sections 10, 11, 13, 14, 15, 16, 21, 22, 23, 24, 25, 26, 27 and 28 of T19S, R15W, in Grant County, New Mexico. The Tyrone open pits cover approximately 2,000 acres with the main pit being approximately 1,400 feet deep. The leach and waste rock stockpiles cover approximately 2,800 acres and contain approximately two billion tons of rock. The Mangas Valley tailings area contains five closed and reclaimed tailings impoundments covering approximately 2,300 acres and associated ground water interception systems and drainage conveyances. The adjacent, inactive Little Rock copper mine is northwest of the Tyrone open pit, with the mine, leach stockpiles, and waste rock covering approximately 600 acres.

2. Open-pit mining at Tyrone began in 1967, and in 1969 a mill and concentrator were constructed adjacent to the open pit. Tailings from the concentrators were deposited west of the open pit mine, on either side of Mangas Wash, through 1992. The Complaint alleges that, once inactive, tailings exposed to air and precipitation release hazardous substances that collect in surface waters and may percolate to ground water. According to the Complaint, these substances include (dependant on the mineralogy of the tailings), but are not limited to, sulfuric acid and dissolved metals, such as arsenic, beryllium, cadmium, chromium, cobalt, copper, lead, manganese, mercury, nickel, selenium, and zinc. The Complaint alleges that sampling results indicate that windblown tailings are deposited off-site according to prevailing winds.

3. In 1972, leaching operations of low-grade ore stockpiles near the open

pit began. Copper was extracted from pregnant leach solutions at on-site precipitation plants. In 1984, a SX/EW plant was constructed east of the open pit, and additional leaching activities began. The Complaint alleges that leach solutions are collected in open channels and ponds, and that these open channels and ponds contain hazardous substances including, but not limited to, sulfuric acid, arsenic, beryllium, cadmium, chromium, cobalt, copper, lead, manganese, mercury, nickel, selenium, and zinc.

4. Surface flows from the Tyrone Mine drain into drainages in the Gila and Mimbres River watersheds. Major drainages at Tyrone include: Mangas Creek, Oak Grove Draw, and Deadman Canyon. The Complaint alleges that these drainages have been contaminated by hazardous substances originating at the Tyrone Mine facilities.

I. Cobre Mine: The Cobre Mine is owned and operated by Freeport-McMoRan Cobre Mining Company, f/k/a Cobre Mining Company, which acquired the mine assets shortly before commencing mining in 1992. The Cobre Mine Site consists of the Continental Pit and underground mine, two mills, the Pearson-Barnes Mine, the Hanover-Empire Zinc Mine, other historic mine workings and associated mine workings and disturbances, underground workings, land, stockpiles, tailings impoundments, waste rock piles, and other related facilities and units located near the towns of Fierro and Hanover, Grant County, New Mexico.

1. The Cobre Mine includes the Continental Mine, located approximately 1/2 mile west of Fierro in Sections 3,4,5,8,9,10,15,16,17, 22, 26, and 27 of T17S, R12W, Grant County, New Mexico. Copper ore was mined from the Continental open pit, which covers about 142 acres and is about 500 feet deep, and the Continental underground mine, which underlies about 124 acres and ranges in depth from 400 to 1,500 feet. There are six rock

stockpiles covering about 294 acres. The Main Tailings Impoundment covers about 140 acres and received tailings from two mills located near the mine. A separate magnetite tailings impoundment is approximately 20 acres in size.

2. The Complaint alleges that, during the 1995-1996 period, five distinct releases of hazardous material were reported by Cobre Mining Company, including 6,000 gallons of mill process water; 80,000 gallons of sediment pond water; 2,000 gallons of tailings; 30-50,000 gallons of mill slurry discharge; and 17,500-52,500 gallons of a tailings/water mix, all of which entered Hanover Creek. The Complaint alleges that the latter spill also included residue from an alcohol-based frother and hydrocarbon-based collector which exceeded permissible levels of cadmium, lead, total nitrogen, and sulfate.

3. The Complaint alleges that, in 1996, four seeps were detected. Three seeps located at the magnetite pond were found to be leaking at the rate of 3 gallons per minute; an acid seep from the west waste rock dump registered a flow of 10 gallons per minute and a pH of 3.5 (exceeding both surface and groundwater standards) and discharged into Buckhorn Gulch and Hanover Creek. The cause of the latter seep was determined to be heavy rains.

4. The Complaint alleges that, in March 1999, a pipeline breach released tailings to nearby stream beds, including Hanover Creek. According to company estimates, about 8 million gallons of tailings escaped. Mining and milling operations at the Cobre Mine were suspended in March 1999.

5. The Complaint alleges that acidic solutions generated by the mine activities have pooled on the surface and injured soils and vegetation. The Complaint further alleges that windblown tailings containing hazardous substances are deposited off-site according to the

direction of prevailing winds.

J. Based on historical studies and additional assessment work, the Trustees have determined that releases of hazardous substances at or from the Sites have occurred and allege that such releases have caused injuries to natural resources at and in the vicinity of the Sites including but not limited to injuries to surface water, sediments, soils, terrestrial habitats, and terrestrial receptors, as well as injury and/or death to migratory birds.

K. The Complaint alleges that the Performing Settling Defendants (as defined below) are liable for damages for injury to, destruction of, or loss of natural resources resulting from the release of hazardous substances at or from the Sites.

L. Pursuant to Executive Order 12580 and the National Contingency Plan, 40 C.F.R. Part 300, the Secretary of the DOI has been delegated authority to act as a Federal Trustee for natural resources managed by the DOI and injured by the release of hazardous substances at or from the Sites.

M. The United States, through DOI, is authorized to seek natural resource damages and related costs under CERCLA, 42 U.S.C. §§ 9601 *et seq.*

N. The State, acting through the ONRT and the AGO, is authorized to seek Natural Resource Damages, including the reasonable costs to assess the damages pursuant to, among other authorities, the New Mexico Natural Resources Trustee Act, N.M. Stat. Ann. § 75-7- 1 through 5 (1978).

O. The ONRT has been delegated authority to act as State Trustee for natural resources impacted by the release of hazardous substances at and from the Sites.

P. The Federal Trustee and the ONRT formed a Trustee Council to coordinate activities

relating to this matter.

Q. Through the Complaint, the Trustees bring claims for recovery of Natural Resource Damages (including recovery of natural resource damage assessment costs) against the Performing Settling Defendants.

R. The Trustees and the Performing Settling Defendants have negotiated regarding the extent of and appropriate compensation for injuries to Natural Resources alleged in the Complaint. This settlement follows an investigation by the Trustees of alleged natural resource injuries related to the release of hazardous substances into the environment at and from the Sites, due at least in part from acid rock drainage, process solutions, smelter emissions, windblown materials, wastes, non-waste materials, and from other areas, sources, and operations at and in the vicinity of the Sites. The Trustees have evaluated potential impacts to natural resources as defined in the DOI regulations at 43 C.F.R. § 11.14(z). These included geological (e.g., terrestrial and riparian soils, aquatic sediments), biological (e.g., aquatic, riparian, and terrestrial ecosystems), and hydrological resources as defined in the DOI regulations at 43 C.F.R. § 11.14. In particular, the Trustees reviewed possible injuries at the Sites and selected areas at and appurtenant to the Sites where historical information suggested releases could have injured natural resources.

S. The Parties recognize that significant improvements have been made on or at the Sites, and therefore adopted reasonable conservative assumptions in assessing natural resource injuries and associated damages that would assure the public is appropriately compensated for such injury and loss. Among those assumptions is that some hazardous substances may continue to be released or to migrate at and from the Sites into the future.

T. This Consent Decree represents a settlement of a contested matter, and neither payment nor the acceptance of any consideration represents an admission of liability or responsibility by any Party. The Parties recognize, and the Court by entering this Consent Decree finds, that this Consent Decree has been negotiated in good faith, that implementation of this Consent Decree will expedite the restoration of allegedly injured natural resources and will avoid prolonged and complicated litigation among the Parties, and that this Consent Decree is fair, reasonable, and in the public interest.

THEREFORE, it is ORDERED, ADJUDGED, AND DECREED as follows:

II. JURISDICTION AND VENUE

1. The Court has jurisdiction over the subject matter of this action pursuant to 28 U.S.C. §§ 1331 and 1345 and Sections 107 and 113 of CERCLA, 42 U.S.C. §§ 9607 and 9613. The Court also has personal jurisdiction over the Performing Settling Defendants. Venue is proper under CERCLA, 42 U.S.C. §§ 9601 *et seq.* Performing Settling Defendants consent to this Court's jurisdiction, and to venue in this District, as to the underlying proceeding giving rise to this Consent Decree, to enforce the terms of this Consent Decree and any subsequent enforcement order stemming from this Consent Decree. In any action to enforce this Consent Decree, the Settling Defendants shall not challenge: (i) that Plaintiffs have stated a claim upon which relief could be granted, (ii) the terms of this Consent Decree, and (iii) this Court's jurisdiction to enter and enforce this Consent Decree.

III. PARTIES BOUND

2. This Consent Decree applies to and is binding upon the United States, the State, and the Settling Defendants and their respective successors and assigns. Any change in ownership

or corporate status of the Settling Defendants including, but not limited to, any transfer of assets or real or personal property, shall in no way alter the Settling Defendants' responsibilities under this Consent Decree.

IV. DEFINITIONS

3. Unless otherwise expressly provided herein, terms used in this Consent Decree that are defined in CERCLA or in regulations promulgated under CERCLA shall have the meaning assigned to them in CERCLA or such regulations. Whenever terms listed below are used in this Consent Decree or its appendices, the following definitions shall apply:

(a) "Affiliate" of an entity means another entity that directly or indirectly (through one or more intermediaries) controls or is controlled by the first entity, or that is controlled by the same entity that controls the first entity.

(b) "AGO" means the New Mexico Attorney General, the New Mexico Attorney General's Office and any successor officers, departments or agencies.

(c) "CERCLA" means the Comprehensive Environmental Response, Compensation, and Liability Act of 1980, as amended, 42 U.S.C. § 9601 *et seq.*

(d) "Consent Decree" means this Consent Decree and all appendices attached hereto (listed in Section XV (Appendices)). In the event of conflict between this Consent Decree and any appendix, this Consent Decree shall control.

(e) "Day" means a calendar day unless expressly stated to be a working day. "Working day" shall mean a day other than Saturday, Sunday, or a federal holiday. In computing any period of time under this Consent Decree, when the last day falls on a Saturday, Sunday, or federal holiday, the period shall run until the close of business of the next working

day.

(f) “DOI” means the United States Department of the Interior and any successor departments or agencies.

(g) “Effective Date” means the effective date of this Consent Decree as provided by Section XVI (Effective Date and Retention of Jurisdiction).

(h) “Federal Trustee” means DOI.

(i) “Future Costs” means any and all direct and indirect costs that the Trustees, the United States, or the State have incurred or will incur after the entry of the Consent Decree in connection with planning, implementing, monitoring, and completing the restoration activity or activities funded through this Consent Decree, or overseeing or enforcing this Consent Decree. Future Costs include administrative and other costs or expenses associated with providing for public participation that are incurred incident to or in support of the restoration process.

(j) “Interest” means interest at the rate specified for interest on investments of the EPA Hazardous Substance Superfund established by 26 U.S.C. § 9507, compounded annually on October 1 of each year, in accordance with 42 U.S.C. § 9607(a). The applicable rate of interest shall be the rate in effect at the time the interest accrues. The rate of interest is subject to change on October 1 of each year.

(k) “Natural Resource” or “Natural Resources” means land, fish, wildlife, biota, air, water, ground water, drinking water supplies, and other such resources, belonging to, managed by, held in trust by, appertaining to, or otherwise controlled by the United States or the State or in which the United States or the State have any legally cognizable interest.

(l) “Natural Resource Damages,” for the purposes of this Consent Decree, means

any damages recoverable by the United States or the State for injury to, destruction of, loss of, loss of use of, or impairment of Natural Resources resulting from the release or threatened release or disposal or presence of hazardous substances at, from, or to the Sites as of and prior to the entry of this Consent Decree, including, but not limited to: (i) the costs of assessing such injury, destruction, loss, loss of use, or impairment; (ii) the costs of restoration, rehabilitation, or replacement of injured or lost Natural Resources or of acquisition of equivalent resources; (iii) the costs of identifying and planning such restoration, rehabilitation, replacement or acquisition activities; (iv) compensation for injury, destruction, loss, loss of use, or impairment of Natural Resources; and (v) each of the categories of recoverable damages described in 43 C.F.R. § 11.15 and/or the NMNRTA.

(m) “NRDAR Fund” means DOI’s Natural Resource Damage Assessment and Restoration Fund.

(n) “ONRT” means the New Mexico Natural Resources Trustee, the New Mexico Office of Natural Resources Trustee and any successor officers, departments or agencies.

(o) “Paragraph” means a portion of this Consent Decree identified by an Arabic numeral or an upper case letter.

(p) “Party” or “Parties” means the United States, the State and/or the Settling Defendants.

(q) “Past Costs” means any and all direct and indirect costs incurred by the Trustees, the United States, or the State prior to the entry of the Consent Decree in assessing the Natural Resources actually or potentially injured, destroyed, or lost as a result of alleged

releases of hazardous substances at, from or to the Sites, in identifying and planning for restoration actions to compensate for such alleged injuries and losses, and in evaluating, assessing or settling potential claims against Performing Settling Defendants and others relating to such alleged injuries and losses.

(r) “Performing Settling Defendants” or “Freeport-McMoRan” means Freeport-McMoRan Corporation, Freeport-McMoRan Chino Mines Company, Freeport-McMoRan Tyrone Inc., Freeport-McMoRan Tyrone Mining LLC, and Freeport-McMoRan Cobre Mining Company, corporations or partnerships doing business in the State of New Mexico.

(s) “Section” means a portion of this Consent Decree identified by an uppercase Roman numeral.

(t) “Settling Defendants” means (1) the Performing Settling Defendants; (2) any persons or entities holding or that have held in the past a partnership interest in any of the Performing Settling Defendants; (3) the successors of the entities identified in items (1) and (2); and (4) the past and present Affiliates of the above-described entities. For the avoidance of doubt, with respect to Natural Resource Damages attributable to the Chino Mine Site, “Settling Defendants” includes Heisei Minerals Corporation, a former general partner of Chino Mines Company; Mitsubishi Corporation and Mitsubishi Materials Corporation, the former 40% and 60% shareholders of Heisei; and the successors, assigns and Affiliates of Heisei, Mitsubishi Corporation, and Mitsubishi Materials Corporation.

(u) “Sites” means the combination of lands, units, structures and facilities associated collectively with the Chino Mine Site, Tyrone Mine Site and Cobre Mine Site. The Sites and vicinity are generally depicted on the map attached as Appendix A.

- (v) “State” means the State of New Mexico, and its officers, departments, agencies and instrumentalities, including the ONRT and the AGO.
- (w) “Subparagraph” means a portion of this Consent Decree identified by a lower case letter or an Arabic numeral in parenthesis.
- (x) “Trustees” means DOI and ONRT.
- (y) “United States” means the United States of America, including all of its departments, agencies and instrumentalities.

V. STATEMENT OF PURPOSE

4. The mutual objectives of the Parties in entering into this Consent Decree are to:
- (i) provide for the restoration, replacement, or acquisition of the equivalent of the Natural Resources allegedly injured, destroyed, or lost as a result of hazardous substances releases at and from the Sites; (ii) reimburse natural resource damage assessment costs incurred by DOI and the State; (iii) resolve the Settling Defendants’ potential liability for Natural Resource Damages as provided herein; and (iv) avoid potentially costly and time-consuming litigation.

VI. PAYMENT BY THE PERFORMING SETTLING DEFENDANTS

5. Prior Payments. The Performing Settling Defendants have already paid \$955,521.01 to the DOI and \$1,467,318.33 to the State for the cooperative, restoration-based natural resource damage assessment activities undertaken by DOI, the State, and their consultants.

6. Payments to be made by Performing Settling Defendants. Within thirty (30) days after the Effective Date, the Performing Settling Defendants shall pay the sum of \$5,559,750.99, as described below and include Defendants’ Taxpayer identification number with each payment:

(a) Past Costs: To the United States Attorney's Office, District of New Mexico, the sum of \$59,750.99, directed to the United States DOI NRDAR Fund, as compensation for DOI Past Costs that the Settling Defendants have not already paid, either by wire transfer per wire instructions that may be obtained from that office, or as specified below:

United States Department of the Interior NRDAR Fund
Department of Interior, NBC/Division of Financial Management Services,
Branch of Accounting Operations, Mail Stop D-2777,
7401 W. Mansfield Avenue, Lakewood, CO 80235.
Account No. – 14X5198 (NRDAR)
Site name – Freeport McMoran – New Mexico Mine Sites,
Location of site – Grant County, NM
Settling Defendants – Freeport McMoRan

(b) Other Payments: The balance after completing the payments required by subparagraph (a), consisting of \$5,500,000, to the United States DOI NRDAR Fund, either by wire transfer or as specified below to be used by DOI and ONRT to plan and implement projects designed to restore, replace, and/or acquire the equivalent of wildlife and wildlife habitat allegedly injured, destroyed, or lost as a result of the release of hazardous substances at or from the Sites:

United States Department of the Interior NRDAR Fund
Department of Interior, NBC/Division of Financial Management Services,
Branch of Accounting Operations, Mail Stop D-2777,
7401 W. Mansfield Avenue, Lakewood, CO 80235.
Account No. – 14X5198 (NRDAR)
Site name – Freeport McMoran – New Mexico Mine Sites,
Location of site - Grant County, NM
Settling Defendants - Freeport McMoRan

Upon request by the Trustees, sums may be withdrawn from the DOI NRDAR Fund to pay for the Trustee-sponsored, natural resource restoration activities described in Section IX of the Consent Decree.

7. Notice of Payment. Upon making any payment under this Consent Decree, Performing Settling Defendants shall send written notice that payment has been made to:

FOR THE UNITED STATES:
Chief, Environmental Enforcement Section
U.S. Department of Justice
DJ # 90-11-3-08069
P.O. Box 7611
Washington, DC 20044-7611

Department of the Interior
Natural Resource Damage Assessment and Restoration Program
Attn: Restoration Fund Manager 1849 C Street, NW
Mailstop 4449
Washington, DC 20240

United States Fish & Wildlife Service
NRDAR Coordinator
Region 2
Attn: Karen Cathey
P.O. Box 1306
Albuquerque, NM 87103

FOR THE STATE:

Rebecca Neri Zagal, Executive Director
New Mexico Office of Natural Resources Trustee
4910-A Alameda Blvd. NE
Albuquerque, NM 87113
Tel: 505-243-8087
Fax: 505-243-6644
rebecca.nerizagal@state.nm.us

with copies to:

Judith Ann Moore Assistant Attorney General
111 Lomas Blvd., NW Suite 300
Albuquerque, NM 87102
Tel: 505-222-9024
Fax: 505-222-9006
AMoore@nmag.gov

8. Remedies for Untimely or Inadequate Payment of Money or Performance of

Other Obligations.

(a) Interest. In the event any payment required by Paragraph 6 is not made when due, the Performing Settling Defendants shall pay Interest on the unpaid balance commencing on the payment due date and accruing through the date of full payment.

(b) Stipulated Penalties. In addition to the Interest required to be paid under the preceding Subparagraph, if any payment required by Paragraph 6 is not made within 14 days after it is due, or if the Performing Settling Defendants fail to perform any non-monetary duties or obligations under this Consent Decree, then the Performing Settling Defendants shall also pay stipulated damages per day in the amounts specified below:

<u>Penalty Per Violation Per Day</u>	<u>Period of Noncompliance</u>
\$1,000	1st through 14th day
\$1,500	15th through 30th day
\$2,000	31st day and beyond

(c) Payment of Interest and Stipulated Penalties. Performing Settling Defendants must pay any Interest payments under Subparagraph 8(a) in the same manner and form as Performing Settling Defendants should have paid the overdue principal amount. Performing Settling Defendants must pay any stipulated penalty payments under Subparagraph 8(b) in the manner and form that Performing Settling Defendants should have paid the principal amount in Paragraph 6.

(d) The payment of stipulated penalties shall not alter in any way Performing Settling Defendants' other obligations required under this Consent Decree.

VII. FORCE MAJEURE

9. For purposes of Section VIII of this Consent Decree, Force Majeure is defined as an event or events arising from a cause or causes beyond the reasonable control of Performing Settling Defendants which could not have been prevented by the exercise of reasonable due diligence and that delay the performance, in whole or in part, of any obligation under this Consent Decree. Notwithstanding the foregoing, "Force Majeure" does not include Performing Settling Defendants' financial inability to perform any obligation under this Consent Decree.

10. Performing Settling Defendants shall notify the Trustees of any delay or anticipated delay in achieving compliance with any requirement of this Consent Decree. When any event occurs or has occurred that may delay or prevent the performance of any obligation under Section VIII of this Consent Decree, Performing Settling Defendants shall notify the Trustees initially by telephone, facsimile, email, or other means as soon as reasonably practicable after Performing Settling Defendants' discovery of the commencement of such event.

11. Initial notification shall be followed by written notification within fifteen (15) days of the date of initial notification. The written notification shall fully describe the reasons for the delay, the reasons the delay is beyond Performing Settling Defendants' control, the anticipated duration of the delay, actions taken or to be taken to prevent or minimize the delay, a schedule for implementation of any measures to be taken to mitigate the effect of the delay, and a statement as to whether, in the opinion of Performing Settling Defendants, such event may cause or contribute to any endangerment to public health, welfare, or the environment. Performing Settling Defendants shall adopt all practicable measures to avoid or minimize such delay.

12. Any delay that Performing Settling Defendants demonstrate results from Force Majeure shall not be deemed to be a violation of their obligations under Section VIII of this Consent Decree and shall not make them liable for stipulated damages. To the extent a delay is attributable to Force Majeure the schedule affected by the delay shall be extended for a period equal to the delay directly resulting from such circumstances. Increased costs of performance of the terms of this Consent Decree, changed economic circumstances, or the failure of Performing Settling Defendants to make timely and complete application for any required approval shall not be considered a Force Majeure.

VIII. TRANSFER OF CERTAIN CITY OF ROCKS AND FAYWOOD CIENEGA RANCH PROPERTY

13. Freeport McMoRan Chino Mines Company warrants that it owns a property approximately one mile south and southwest of City of Rocks, New Mexico, commonly known as “City of Rocks” and “Faywood Cienega.” As one component of the settlement embodied in this Consent Decree, Freeport-McMoRan Chino Mines Company must execute and record a warranty deed transferring to the State of New Mexico approximately 715 acres in compliance with the requirements of this Consent Decree and any other applicable New Mexico law. The purposes of the transfer of ownership is to generate benefits from natural resources to offset benefits lost on account of the damage to natural resources alleged in the Complaint.

14. The form of the warranty deed is included in Appendix B to this Consent Decree. Appendix B also includes the legal description of the property to be transferred. Prior to the transfer, the Performing Settling Defendants shall construct a fence around the parcel that meets the specifications set forth in Appendix C, or an equivalent design that is satisfactory to both Performing Settling Defendants and the State. Performing Settling Defendants shall

also reasonably cooperate with the State regarding the process for due diligence and acquisition of the parcel, as set forth in the Donation Agreement between the State of New Mexico Energy, Minerals and Natural Resources Department, State Parks Division (“Grantee”), the New Mexico Natural Resources Trustee (“the Trustee”) and Freeport-McMoRan Chino Mines Company (“Grantor”), included as Appendix D to this Consent Decree. Within six months of the Effective Date, Freeport-McMoRan Chino Mines Company and the State shall execute and record the warranty deed, in substantially the form attached hereto as Appendix B, with the Grant County Clerk’s Office, unless the parties file a joint stipulation with this Court which reflects their agreement to a different deadline for completion of the tasks required by this Paragraph.

IX. TRUSTEE-SPONSORED NATURAL RESOURCE RESTORATION PROJECTS

15. Management and Application of Funds. All funds disbursed from the DOI NRDAR Fund Account pursuant to Subparagraph 6(b) shall be used to pay for Future Costs and Trustee-sponsored natural resource restoration activities in accordance with this Consent Decree and applicable law. All such funds shall be applied toward the costs of restoration, rehabilitation, or replacement of injured Natural Resources, and/or acquisition of equivalent resources, including but not limited to any administrative costs and expenses for, and incidental to, restoration, rehabilitation, replacement, and/or acquisition of equivalent resources planning, and any restoration, rehabilitation, replacement, and/or acquisition of equivalent resources undertaken.

16. Restoration Planning. The Trustees intend to prepare one or more separate Restoration Plans describing how the funds dedicated for Trustee-sponsored natural resource restoration efforts under this Section will be used. As provided by 43 C.F.R. § 11.93, the Plan or

Plans will identify how funds will be used for restoration, rehabilitation, replacement, or acquisition of equivalent resources. The Plan or Plans may also identify how funds will be used to address services allegedly lost to the public until restoration, rehabilitation, replacement, and/or acquisition of equivalent resources is completed. The Trustees intend to solicit public review and comment on the Restoration Plan or Plans and in no event will any project proceed without the public first receiving the opportunity to review the proposed project and submit comments on the proposal to the Trustees.

17. The Trustees, acting through the Trustee Council, shall make decisions regarding any use or expenditure of funds in the DOI NRDAR Fund under this Section. The Settling Defendants shall not be entitled to dispute, in any forum or proceeding, any decision relating to use of funds or restoration efforts under this Section, provided that Settling Defendants may exercise whatever rights they, or any of them, may have as a member of the general public concerning such decisions, without reference to the terms of this Consent Decree or the settlement negotiations that led to this Consent Decree but without violating any term of this Consent Decree.

X. COVENANTS NOT TO SUE BY THE UNITED STATES AND THE STATE

18. Covenant by the United States. Except as specifically provided by Paragraph 20 (General Reservations) and Paragraph 21 (Limitations on Covenant Regarding Natural Resource Damages), the United States covenants not to sue or take any civil or administrative action pursuant to CERCLA Section 107, 42 U.S.C. § 9607, or Section 311(f)(4) & (5) of the Clean Water Act (“CWA”), 33 U.S.C. § 1321(f)(4) & (5), or other statute or common law against the Settling Defendants for: a) Natural Resource Damages as defined in this Consent Decree; b)

Past Costs; and c) Future Costs. This covenant shall take effect upon receipt by the DOI NRDAR Fund of the Performing Settling Defendants' principal payment pursuant to Paragraph 6(b) of this Consent Decree. This covenant is conditioned upon the Performing Settling Defendants' full and satisfactory performance of their duties and obligations under this Consent Decree. This covenant extends only to Settling Defendants and expressly does not extend to any other person or entity.

19. Covenant by the State. Except as specifically provided by Paragraph 20 (General Reservations) and Paragraph 21 (Limitations on Covenant Regarding Natural Resource Damages), the State covenants not to sue or take any civil or administrative action pursuant to CERCLA Section 107, 42 U.S.C. § 9607, Section 311(f)(4) & (5) of the CWA, 33 U.S.C. § 1321(f)(4) & (5), or the NMNRTA, NMSA 1978 Sections 75-7-I through J, or other statute or common law against the Settling Defendants for: a) Natural Resource Damages; b) Past Costs; and c) Future Costs. This covenant is conditioned upon the Performing Settling Defendants' full and satisfactory performance of their duties and obligations under this Consent Decree. This covenant extends only to Settling Defendants and expressly does not extend to any other person or entity.

XI. RESERVATION OF RIGHTS BY THE UNITED STATES AND THE STATE

20. General Reservations. The United States and the State reserve, and this Consent Decree is without prejudice to, all rights against the Settling Defendants with respect to all matters not expressly included within Paragraph 18 (Covenant by the United States) and Paragraph 19 (Covenant by the State). Notwithstanding any other provisions of this Consent Decree, the United States and the State reserve all rights against the Settling Defendants with

respect to:

- (a) claims based on a failure by the Performing Settling Defendants to meet a requirement or fulfill a duty or obligation of this Consent Decree;
- (b) liability for injunctive relief or administrative order enforcement under CERCLA Section 106, 42 U.S.C. § 9606, the CWA Section 311, 33 U.S.C. § 1321, or applicable state law;
- (c) liability under CERCLA Section 107(a)(4)(A), 42 U.S.C. § 9607(a)(4)(A), the CWA, Section 311, 33 U.S.C. § 1321, or applicable state law for the costs of removal or remedial actions by the United States, the State or an Indian tribe;
- (d) liability under CERCLA Section 107(a)(4)(D), 42 U.S.C. § 9607(a)(4)(D), for costs of any health assessment or health effects study carried out under 42 U.S.C. § 9604(i);
- (e) liability for any damages or costs incurred or to be incurred by the United States or by the State that are not within the definition of Natural Resource Damages, Past Costs or Future Costs;
- (f) liability for damages to Natural Resources resulting from releases of hazardous substances other than at or from the Sites and occurring after the date of entry of this Consent Decree.
- (g) criminal liability;
- (h) liability arising from the past, present, or future disposal or release of a hazardous substance outside the Sites.

21. Limitations on Covenant Regarding Natural Resource Damages.

- (a) Notwithstanding any other provision of this Consent Decree, the

United States and the State each separately reserves and retains the right to institute proceedings against the Performing Settling Defendants in this action or in a new action to secure Natural Resource Damages including the costs of damage assessment for possible Natural Resource Damages relating to the Sites and resulting from the release of hazardous substances at or from the Sites where: (1) any condition at one or more of the Sites that was unknown to Trustees as of the entry of this Consent Decree is discovered and causes or contributes to injury to, destruction or loss of Natural Resources materially greater or materially different from that known and assessed as of the entry of this Consent Decree; or (2) any information, unknown to the Trustees at the time of entry of this Consent Decree, is received by Trustees and the Trustees determine that this unknown information together with any other relevant information indicates that the damages to Natural Resources may be materially greater than assessed by the Trustees as of the entry of this Consent Decree; or (3) after completion of remedial investigation and feasibility study for one or more of the Sites under CERCLA, (i) Performing Settling Defendants fail to perform timely any CERCLA response action selected or approved for any of the Sites by the United States; and (ii) such failure to perform or its untimely performance contributes to an injury to, destruction of, or loss of Natural Resources materially greater than or materially different from that assessed by the Trustees.

(b) An immaterial increase in the assessed size of injury when compared to the assessment based on the information within the knowledge of the Trustees as of the entry of this Consent Decree or an immaterial increase in the rate or quantity of release of hazardous substances compared to the rate or quantity of release as of when this Consent Decree was entered is not, standing alone, a basis for invoking the limitation on the covenant established by

this Paragraph.

22. While this Consent Decree requires Performing Settling Defendants to make a payment into a DOI account as specified in Paragraph 6(b) to be jointly administered by all Trustees, as between the Trustees each Trustee reserves its rights concerning its trustee status with respect to specific trust resources.

XII. COVENANTS BY SETTLING DEFENDANTS

23. Covenants by the Settling Defendants. The Settling Defendants covenant not to sue and agree not to assert any claims or causes of action against the United States and the State, or their respective contractors, agents, officials or employees, with respect to Natural Resource Damages covered by the covenants not to sue contained in Paragraphs 18 and 19 above, including but not limited to:

(a) any direct or indirect claim for reimbursement of any payment for Natural Resource Damages from the Hazardous Substance Superfund based on Sections 106(b)(2), 107, 111, 112, or 113 of CERCLA, 42 U.S.C. §§ 9606(b)(2), 9607, 9611, 9612, or 9613, Section 311 of the CWA, 33 U.S.C. § 1321, or any other provision of law; and

(b) any claim against the United States or the State pursuant to Sections 107 and 113 of CERCLA, 42 U.S.C. §§ 9607 and 9613, and Section 311 of the CWA, 33 U.S.C. § 1321, relating to Natural Resource Damages. These covenants not to sue shall not apply in the event that the United States or the State brings a claim against Settling Defendants pursuant to the reservations set forth in Paragraphs 20 or 21 above, but only to the extent and for the same matters, transactions, or occurrences as are raised in the claims asserted by the United States or the State pursuant to such reservations. Nothing in this Consent Decree shall be deemed to constitute

approval or preauthorization of a claim within the meaning of Section 111 of CERCLA, 42 U.S.C. § 9611, or 40 C.F.R. § 300.700(d).

XIII. EFFECT OF SETTLEMENT - CONTRIBUTION PROTECTION

24. Nothing in this Consent Decree shall be construed to create any rights in, or grant any cause of action to, any person not a Party to this Consent Decree. Each of the Parties expressly reserves any and all rights (including, but not limited to, any right to contribution), defenses, claims, demands, and causes of action that each Party may have with respect to any matter, transaction, or occurrence relating in any way to the Sites against any person not a Party hereto.

25. The Parties agree, and by entering this Consent Decree this Court finds, that the Settling Defendants are entitled, as of the Effective Date of this Consent Decree, to protection from contribution actions or claims as provided by Section 113(f)(2) of CERCLA, 42 U.S.C. § 9613(f)(2), and other federal or state laws, for “matters addressed” in this Consent Decree. The “matters addressed” in this Consent Decree are Past Costs, Future Costs, and Natural Resource Damages.

26. The Settling Defendants agree that, with respect to any suit or claim for contribution brought against them or any of them for matters related to this Consent Decree, the Settling Defendants shall notify the persons identified in Section XIV (Notices) in writing within 30 days of service of the complaint or claim upon it. In addition, the Settling Defendants shall notify the persons identified in Section XIV (Notices) within 15 days of service or receipt of any motion for summary judgment (or within 5 business days of receipt if a response would be due in less than 15 days), and within 15 days of receipt of any order from a court

setting a case for trial, for matters related to this Consent Decree.

27. Waiver of Claim-Splitting Defenses. In any subsequent administrative or judicial proceeding initiated by the United States or the State for injunctive relief, recovery of response costs or natural resource damages, or other relief relating to the Sites, the Settling Defendants shall not assert, and may not maintain, any defense or claim based upon the principles of waiver, res judicata, collateral estoppel, issue preclusion, claim-splitting, or other defenses based upon any contention that the claims raised by the United States or the State in the subsequent proceeding were or should have been brought in the instant case; provided, however, that nothing in this Paragraph affects the enforceability of the Covenants Not to Sue by the United States and the State set forth in Section X.

XIV. NOTICES

28. Whenever, under the terms of this Consent Decree, notice is required to be given or a document is required to be sent by one Party to another, it shall be directed to the individuals at the addresses specified below, unless those individuals or their successors give notice of a change to the other Parties in writing. Written notice as specified in this Section shall constitute complete satisfaction of any written notice requirement of the Consent Decree.

AS TO THE UNITED STATES:

As to the Department of Justice:

Chief, Environmental Enforcement Section
Environment and Natural Resources Division
United States Department of Justice
DJ# 90-11-3-08069

U.S. Mail Only
P.O. Box 7611
Washington, DC 20044-7611

Overnight Mail Only
601 D Street, N.W.
ENRD Mailroom, Room 2121

Washington, DC 20004

As to the Department of the Interior:

United States Fish & Wildlife Service
NRDAR Coordinator
Region 2
Attn: Karen Cathey
P.O. Box 1306
Albuquerque, NM 87103

Dori Richards
Office of the Solicitor
United States Department of the Interior
Regional Office, Southwest Region
505 Marquette Avenue NW
Suite 1800
Albuquerque, NM 87102

AS TO THE STATE:

Rebecca Neri Zagal
New Mexico Office of Natural Resources Trustee
4910-A Alameda Blvd. NE
Albuquerque, NM 87113

Judith Ann Moore
Assistant Attorney General
111 Lomas Blvd., NW Suite 300
Albuquerque, NM 87102
Tel: 505-222-9024
Fax: 505-222-9006

AS TO SETTLING DEFENDANTS:

Dalva L. Moellenberg
Gallagher & Kennedy, P.A.
2575 E. Camelback Road
Phoenix, Arizona 85016
Tel. (602) 530-8000
Fax (602) 530-8500
dlm@gknet.com

Freeport-McMoRan Copper & Gold Inc.
Attn: General Counsel
333 North Central Avenue
Phoenix, Arizona 85004
Tel. (602) 366-8114
Fax: (602) 453-1604

XV. APPENDICES

29. The following appendices are attached to and incorporated into this Consent Decree:

“Appendix A” is a map generally depicting the Sites and surrounding land in the vicinity.

“Appendix B” is a form of deed and a legal description of real property.

“Appendix C” contains fencing specifications acceptable to the Trustees.

“Appendix D” is a Donation Agreement between the State of New Mexico, Energy, Minerals and Natural Resources Department, State Parks Division (“Grantee”), the New Mexico Natural Resources Trustee (“the Trustee”) and Freeport-McMoRan Chino Mines Company (“Grantor”).

XVI. EFFECTIVE DATE AND RETENTION OF JURISDICTION

30. This Consent Decree shall take effect upon entry by the Court.

31. This Court shall retain jurisdiction to modify and enforce the terms and conditions of this Consent Decree and to resolve disputes arising hereunder as may be necessary or appropriate for the construction or execution of this Consent Decree.

XVII. CONSENT DECREE MODIFICATIONS

32. Any material modification of this Consent Decree shall be made by agreement of the Parties to this Consent Decree and in writing, and shall not take effect unless approved by the Court. Any non-material modification of this Consent Decree shall be made by agreement of the

Parties to this Consent Decree and in writing, and shall not take effect until filed with the Court. Nothing in this Consent Decree shall be deemed to alter the Court's power to enforce, supervise, or approve modifications to this Consent Decree.

33. The provisions of this Consent Decree are not severable. The Parties' consent hereto is conditioned upon the entry of the Consent Decree in its entirety without modification, addition, or deletion except as agreed to by the Parties.

34. Economic hardship or changed financial circumstances of the Performing Settling Defendants shall not serve as a basis for modifications of this Consent Decree.

XVIII. LODGING AND OPPORTUNITY FOR PUBLIC COMMENT

35. This Consent Decree shall be lodged with the Court for a period of not less than 30 days for public notice and comment. The United States and the State reserve the right to withdraw or withhold their consent if comments regarding the Consent Decree disclose facts or considerations which indicate that this Consent Decree is inappropriate, improper, or inadequate. The Settling Defendants consent to the entry of this Consent Decree in the form presented without further notice. If for any reason the Court should decline to approve this Consent Decree in the form presented, or if approval and entry is subsequently vacated on appeal of such approval and entry, this Consent Decree is voidable at the sole discretion of any Party and the terms of this Consent Decree may not be used as evidence in any litigation among the Parties.

XIX. SIGNATORIES / SERVICE

36. The undersigned representatives of the Settling Defendants, the United States, and the State each certify that he or she is fully authorized to enter into this Consent Decree and to

execute and legally bind such Party to this Consent Decree. This Consent Decree may be executed in multiple counterparts, each of which shall be deemed an original, but all of which, taken together, shall constitute one and the same instrument.

37. The Settling Defendants hereby agree not to oppose entry of this Consent Decree (in the form presented) by this Court or to challenge any provision of this Consent Decree unless the United States or the State has notified the Settling Defendants in writing that it no longer supports entry of the Consent Decree.

38. The Performing Settling Defendants shall identify, on the attached signature pages, the name, address and telephone number of an agent who is authorized to accept service of process by mail on behalf of the Performing Settling Defendants with respect to all matters arising under or relating to this Consent Decree. The Performing Settling Defendants hereby agree to accept service in that manner and to waive the formal service requirements set forth in Rule 4, Fed. R. Civ. P. and any applicable local rules of this Court, including but not limited to the requirements for service of a summons.

XX. FINAL JUDGMENT

39. This Consent Decree and its appendices constitute the final, complete, and exclusive understanding among the Parties with respect to the settlement embodied in the Consent Decree. The Parties acknowledge that there are no representations, agreements, or understandings relating to the settlement other than those expressly contained in this Consent Decree.

40. Upon approval and entry of this Consent Decree by the Court, this Consent Decree shall constitute a final judgment between and among the United States, the State and the

Settling Defendants. The Court finds that there is no reason for delay and therefore enters this judgment as a final judgment under Rules 54 and 58 of the Federal Rules of Civil Procedure.

SO ORDERED this _____ day of _____, 2012.



United States District Court Judge
District of New Mexico

THE UNDERSIGNED PARTIES enter into this Consent Decree in *United States of America & State of New Mexico v. Freeport-McMoRan Corporation, et al.*

FOR THE UNITED STATES OF AMERICA:

Date: 12/28/11



ROBERT G. DREHER
Acting Assistant Attorney General
United States Department of Justice
Environment and Natural Resources Division

Date: 12/29/11

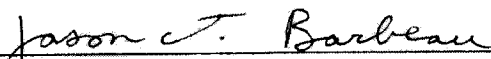

JASON T. BARBEAU
Trial Attorney (D.C. Bar No. 468200)
United States Department of Justice
Environment and Natural Resources Division
Environmental Enforcement Section
P.O. Box 7611 Ben Franklin Station
Washington, DC 20044
(202) 616-8908 (Telephone)
(202) 616-6584 (Facsimile)
jason.barbeau@usdoj.gov

KENNETH J. GONZALES
United States Attorney

ANDREW A. SMITH
Trial Attorney (NM Bar #8341)
United States Department of Justice
Environment and Natural Resources Division
Natural Resources Section
c/o U.S. Attorney's Office
P.O. Box 607
Albuquerque, New Mexico 87103
(505) 224-1468 (Telephone)
andrew.smith@usdoj.gov

THE UNDERSIGNED PARTIES enter into this Consent Decree in *United States & State of New Mexico v. Freeport-McMoRan Corporation, et al.*

FOR THE STATE OF NEW MEXICO:

Date: 12-22-2011

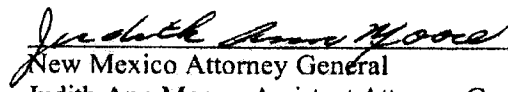

New Mexico Attorney General
Judith Ann Moore, Assistant Attorney General
Office of New Mexico Attorney General
111 Lomas Blvd. NW, Suite 300
Albuquerque, NM 87102
Tel: 505-222-9024
Fax: 505-222-9006
AMoore@nmag.gov

Date: _____

David Martin
Natural Resources Trustee
N.M. Office of Natural Resources Trustee
4910-A Alameda Blvd. NE
Albuquerque, NM 87113
Tel: 505-243-8087
Fax: 505-243-6644
david.martin@state.nm.us

THE UNDERSIGNED PARTIES enter into this Consent Decree in *United States & State of New Mexico v. Freeport-McMoRan Corporation, et al.*

FOR THE STATE OF NEW MEXICO:

Date: _____

New Mexico Attorney General
Judith Ann Moore, Assistant Attorney General
Office of New Mexico Attorney General
111 Lomas Blvd. NW, Suite 300
Albuquerque, NM 87102
Tel: 505-222-9024
Fax: 505-222-9006
AMoore@nmag.gov

Date: 12-22-11

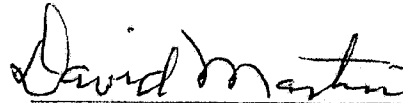

David Martin
Natural Resources Trustee
N.M. Office of Natural Resources Trustee
4910-A Alameda Blvd. NE
Albuquerque, NM 87113
Tel: 505-243-8087
Fax: 505-243-6644
david.martin@state.nm.us

THE UNDERSIGNED PARTIES enter into this Consent Decree in *United States & State of New Mexico v. Freeport-McMoRan Corporation, et al.*

FOR FREEPORT-MCMORAN CORPORATION:

Date: 12/28/11



L. Richards McMillan II
Senior Vice President
333 North Central Avenue
Phoenix, Arizona 85004

FOR FREEPORT-MCMORAN CHINO MINES COMPANY, a New Mexico general partnership:

Date: 12/28/11

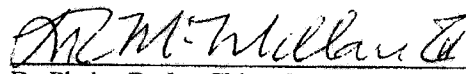

By Phelps Dodge Chino, Inc.
its General Partner
L. Richards McMillan II
Senior Vice President
333 North Central Avenue
Phoenix, Arizona 85004

Date: 12/28/11

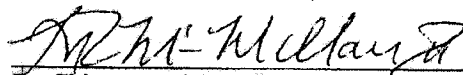

By Chino Acquisition Inc.
its General Partner
L. Richards McMillan II
Senior Vice President
333 North Central Avenue
Phoenix, Arizona 85004

FOR FREEPORT-MCMORAN TYRONE MINING LLC, a New Mexico limited liability company:

Date: 12/28/11



By Freeport-McMoRan Tyrone Inc.

its Manager

L. Richards McMillan II

Senior Vice President

333 North Central Avenue

Phoenix, AZ 85004

FOR FREEPORT-MCMORAN TYRONE INC.:

Date: 12/28/11



L. Richards McMillan II

Senior Vice President

333 North Central Avenue

Phoenix, AZ 85004

FOR FREEPORT-MCMORAN COBRE MINING COMPANY:

Date: 12/28/11

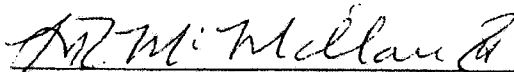

L. Richards McMillan II

Senior Vice President

333 North Central Avenue

Phoenix, AZ 85004

Designated Agent per Section XIX:

Date: 12/27/11



GALLAGHER & KENNEDY, P.A.
Dalva L. Moellenberg
Gallagher & Kennedy, P.A.
2575 E. Camelback Road
Phoenix, Arizona 85016
Tel: (602) 530-8000
Fax: (602) 530-8500
dlm@gknet.com
Attorneys for Freeport-McMoRan Corporation,
Freeport-McMoRan Chino Mines Company,
Freeport-McMoRan Tyrone Inc., Freeport-
McMoRan Tyrone Mining LLC, Freeport-
McMoRan Cobre Mining Company

APPENDIX A

Preliminary Estimate of Phelps Dodge NRDAR Assessment Areas

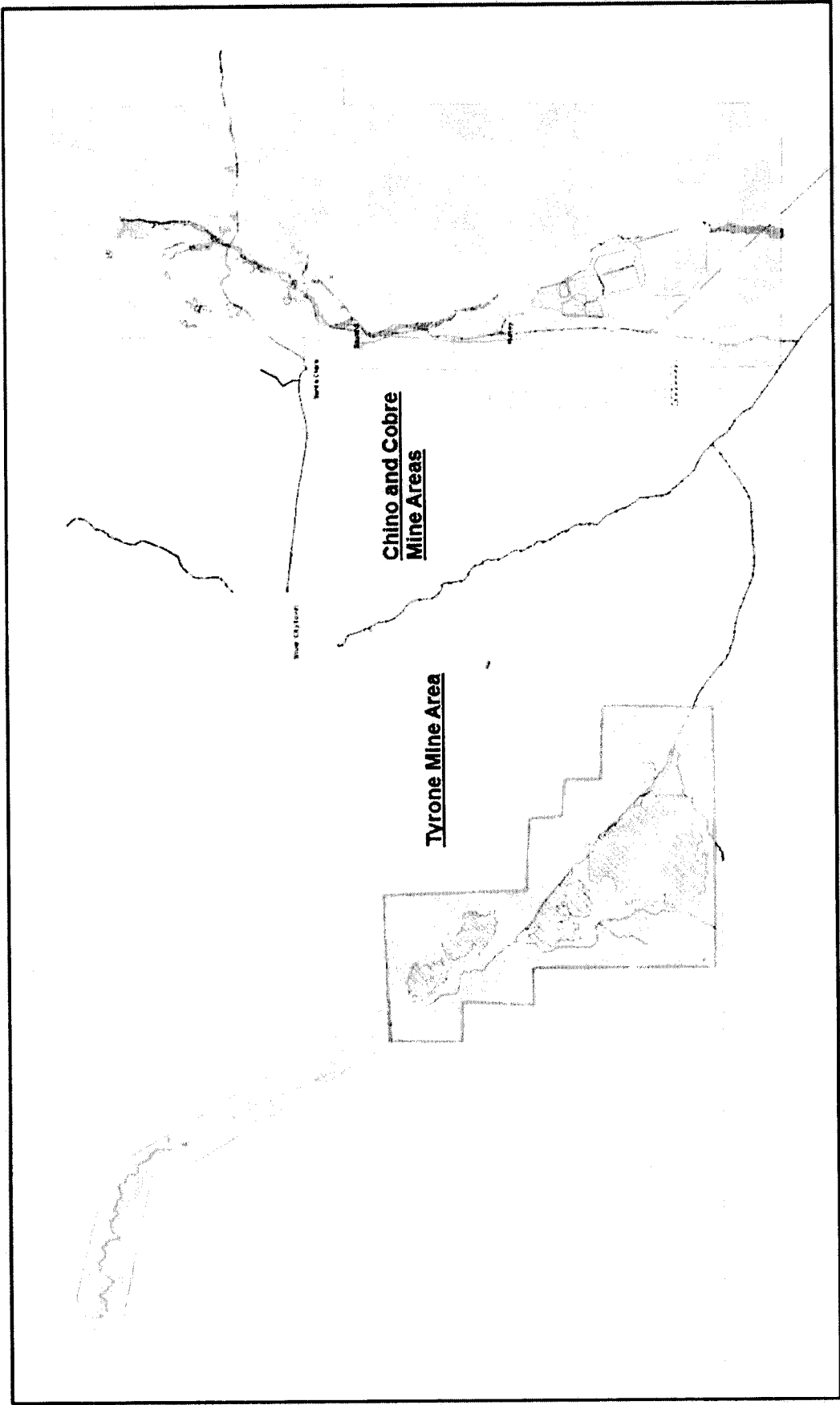

APPENDIX B

APPENDIX B

WARRANTY DEED

Freeport-McMoRan Chino Mines Company, a New Mexico General Partnership, f/k/a Chino Mines Company, for consideration paid, grants to State of New Mexico Energy, Minerals, and Natural Resources Department, State Parks Division, whose address is 1220 St. Francis Drive, Santa Fe, NM 87505, the following described real estate in GRANT County, New Mexico:

SEE ATTACHED EXHIBIT "A"

Subject to any easements, restrictions and reservations of record.

with warranty covenants.

WITNESS my hand and seal this _____ day of _____, 2012

Freeport-McMoRan Chino Mines Company

by: _____ (Seal) _____ (Seal)

ACKNOWLEDGEMENT

FOR RECORDER'S USE ONLY

STATE OF _____ }
COUNTY OF _____ } SS

This instrument was acknowledged before me this _____ day of _____, 2012, by _____ of **Freeport-McMoRan Chino Mines Company, a New Mexico General Partnership**, on behalf of said general partnership.

Notary Public

My commission expires: [_____]
(Seal)

EXHIBIT "A"

Legal Description - Parcel A

A parcel of land within Sections 9, 10 & 16, T20S, R11W, NMPM, Grant County, New Mexico, being more particularly described as follows:
Beginning at corner 1, the SE corner of the W46SW¼ and a point on the boundary of the City of Rocks State Park tract, whence the NE corner of the W46SW¼ bears N01°58'23"W (record), a distance of 2639.50 feet;
Thence along said boundary of the City of Rocks State Park tract S89°25'28"W, a distance of 1277.84 feet to corner 2, the SW corner of Section 10;
Thence continuing along said boundary of the City of Rocks State Park tract S01°52'43"W, a distance of 5305.11 feet to corner 3, the SW corner, also being a point on the easterly right-of-way of the City of Rocks State Park Access Road;
Thence along said easterly right-of-way N02°24'06"W, a distance of 2860.94 feet to corner 4;
Thence continuing along said easterly right-of-way on the arc of a curve to the right, having a central angle of 43°53'32", a radius of 472.96 feet, a length of 353.53 feet, and a chord bearing N17°47'21"E, a distance of 362.31 feet to corner 5, a point of non-tangency;
Thence continuing along said easterly right-of-way on the arc of a curve to the left, having a central angle of 31°52'51", a radius of 1145.92 feet, a length of 629.43 feet, and a chord bearing N22°26'33"E, a distance of 637.62 feet to corner 6, a point of non-tangency;
Thence continuing along said easterly right-of-way N07°07'39"E, a distance of 857.07 feet to corner 8;
Thence continuing along said easterly right-of-way on the arc of a curve to the left, having a central angle of 21°14'19", a radius of 871.72 feet, a length of 321.29 feet, and a chord bearing N69°36'40"W, a distance of 323.13 feet to corner 9, a point of non-tangency;
Thence continuing along said easterly right-of-way N06°47'00"W, a distance of 127.91 feet to corner 10, the NW corner, also being a point on the south boundary of the City of Rocks State Park;
Thence along said south boundary of the City of Rocks State Park S89°42'06"E, a distance of 320.35 feet to corner 11, the NE corner, also being the NE corner of the W46SW¼;
Thence along the east boundary of the City of Rocks State Park S01°58'23"E, a distance of 2639.50 feet to corner 1, the point of beginning;
Said parcel contains 43.378 acres, more or less.

Legal Description - Parcel B

A parcel of land within Sections 9, 10 & 16, T20S, R11W, NMPM, Grant County, New Mexico, being more particularly described as follows:
Beginning at corner 1, a point on the northerly right-of-way of New Mexico Highway No. 61, whence the SE corner of Section 16 bears S89°05'39"E, a distance of 1782.34 feet;
Thence N89°05'39"W, a distance of 2886.96 feet to corner 2, the SW corner, whence the SW corner of Section 16 bears N89°05'39"W, a distance of 367.46 feet;
Thence N00°04'00"W, a distance of 2908.33 feet to corner 3;
Thence N89°58'00"E, a distance of 3482.26 feet to corner 4;
Thence N02°19'39"W, a distance of 1743.03 feet to corner 5;
Thence N09°41'52"E, a distance of 342.31 feet to corner 6;
Thence N24°55'55"E, a distance of 404.20 feet to corner 7;
Thence N34°46'30"E, a distance of 1424.82 feet to corner 8;
Thence N06°37'59"E, a distance of 833.19 feet to corner 9;
Thence N10°11'32"W, a distance of 439.76 feet to corner 10, the NW corner, also being a point on the south boundary of the City of Rocks State Park tract;
Thence along said south boundary of the City of Rocks State Park tract S89°42'06"E, a distance of 835.42 feet to corner 11, the NE corner, also being a point on the westerly right-of-way of the City of Rocks State Park Access Road;
Thence along said westerly right-of-way S09°47'00"E, a distance of 149.73 feet to corner 12;
Thence continuing along said westerly right-of-way on the arc of a curve to the right, having a central angle of 21°30'36", a radius of 771.72 feet, a length of 288.03 feet, and a chord bearing S03°48'28"E, a distance of 289.73 feet to corner 13, a point of non-tangency;
Thence continuing along said westerly right-of-way on the arc of a curve to the right, having a central angle of 31°58'33", a radius of 1045.92 feet, a length of 575.88 feet, and a chord bearing S22°26'33"W, a distance of 583.10 feet to corner 15, a point of non-tangency;
Thence continuing along said westerly right-of-way S37°41'22"W, a distance of 1114.88 feet to corner 16;
Thence continuing along said westerly right-of-way on the arc of a curve to the left, having a central angle of 43°52'04", a radius of 572.96 feet, a length of 424.95 feet, and a chord bearing S17°48'52"W, a distance of 435.34 feet to corner 17, a point of non-tangency;
Thence continuing along said westerly right-of-way S02°17'33"E, a distance of 3786.33 feet to corner 18, the SE corner, also being a point on the northerly right-of-way of New Mexico Highway No. 61;
Thence along said northerly right-of-way on the arc of a curve to the left, having a central angle of 38°01'42", a radius of 2864.79 feet, a length of 1771.48 feet, and a chord bearing S63°52'00"W, a distance of 1801.01 feet to corner 19, a point of non-tangency;
Thence continuing along said westerly right-of-way S46°59'00"W, a distance of 213.12 feet to corner 1, the point of beginning;
Said parcel contains 361.049 acres, more or less.

LEGAL DESCRIPTION PARCEL C

A parcel of land within Section 3, T20S, R11W, NMPM, Grant County, New Mexico, being more particularly described as follows:
Beginning at corner 1, the SE corner of the herein described parcel, also being the SE corner of Section 3 and a point on the boundary of the City of Rocks State Park tract, whence the NE corner of Section 3 bears N01°41'00"W (record), a distance of 5277.75 feet;
Thence along said boundary of the City of Rocks State Park tract S89°43'39"W, a distance of 2663.45 feet to corner 2, the SW corner, and also being a point on the common boundary of Sections 10 and 3;
Thence continuing along said boundary of the City of Rocks State Park tract N00°43'32"E, a distance of 3259.59 feet to corner 3;
Thence N00°43'32"E, a distance of 2049.95 feet to corner 4, the NW corner, and also being a point on the North boundary of Section 3, from whence the NW Corner of Section 3 bears N89°30'28"W, a distance of 2790.65 feet;
Thence along said North boundary of Section 3 S89°30'28"E, a distance of 2441.29 feet to corner 5, the NE corner, also being the NE corner of Section 3 and a point on said boundary of the City of Rocks State Park tract;
Thence along said boundary of City of Rocks State Park tract S01°41'00"E, a distance of 5277.75 feet to corner 1, the point of beginning;
Said parcel contains 310.085 acres, more or less.

APPENDIX C

APPENDIX C

Upland fence segments would consist of modified BLM Type A design 4-strand, with top and bottom strands smooth (see Figure below). Wire spacing would be 16", 8", 8" and 10" from the ground up, for a total height of 42". Braces and corners would be wood or steel. Line posts will be 6-ft. steel T-posts spaced at 16' intervals. There will be no gates or cattle guards. Arroyo crossings would be constructed in the same manner as upland segments, but they would terminate at "deadmen" that are not tied into upland segments.

Sample fence wire diagram and fence installation x-section.

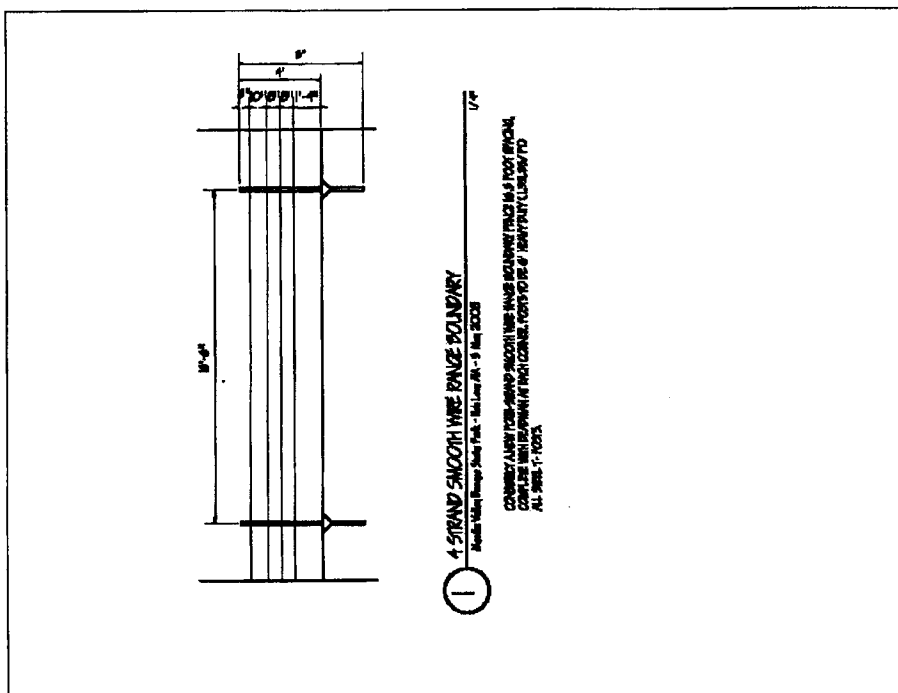

APPENDIX D

APPENDIX D

DRAFT **DONATION AGREEMENT**

THIS DONATION AGREEMENT is entered into by and between the State of New Mexico, Energy, Minerals and Natural Resources Department, State Parks Division ("Grantee"), the New Mexico Natural Resources Trustee ("the Trustee") and Freeport-McMoRan Chino Mines Company ("Grantor").

RECITALS:

WHEREAS, Grantor is the owner of approximately seven hundred fifteen acres (715) acres of land adjacent or contiguous to City of Rocks State Park ("the Property"); and

WHEREAS, Grantor desires to donate the Property to Grantee pursuant to the terms of the Consent Decree entered into between the United States of America, the State of New Mexico, Freeport-McMoRan Corporation, Freeport-McMoRan Chino Mines Company, Freeport-McMoRan Tyrone Inc., Freeport-McMoRan Tyrone Mining LLC, and Freeport-McMoRan Cobre Mining Company; and

WHEREAS, Grantee desires to accept title to the Property as part of City of Rocks State Park, pursuant to NMSA 1978, Section 16-2-11(J), upon approval by the State Board of Finance and with consultation of local government officials in Grant County.

NOW, THEREFORE, it is mutually agreed as follows:

1. Donation of the Property. In accordance with the terms stated herein, Grantor proposes to donate, and Grantee proposes to accept, title to the Property.

2. Legal Description of Property. Grantor shall provide Grantee a legal description for the Property based upon a survey prepared by a licensed professional surveyor. Grantor, Grantee and Trustee agree that the Property shall be comprised of those parcels of land shown on Exhibit "1" to this Agreement containing approximately 715 acres of land south of the Town of Hurley and adjacent or contiguous to City of Rocks State Park.

3. Contingencies. The donation shall be consummated upon the closing date set forth herein. However, in the event the contingencies set forth below shall not have been satisfied within fifteen (15) days of the date of closing (or as agreed to between the parties in writing or otherwise provided below), Grantee shall have no obligation to accept the Property. The contingencies are as follows:

(a) A current and accurate metes and bounds survey and site improvement survey plat for the Property, to be provided by Grantor and acceptable to Grantee, prepared by a licensed professional surveyor in order to provide a legal description of the Property and to

identify any easements or encroachments that may exist on the Property. Grantor shall pay the costs for acquisition of the survey.

(b) Title commitment and standard owner's title policy for the Property, to be provided by Grantor and acceptable to Grantee, naming the State of New Mexico, Energy, Minerals and Natural Resources Department, State Parks Division, as insured owner and evidencing clear title, with agreement by the title company that it will delete General Exceptions 1 through 6. Grantor shall order the title commitment within five (5) days after the date of this Agreement. Grantee shall have thirty (30) days to review and object to the title exceptions. The title policy shall contain no special exceptions. Grantee may choose to require the exceptions be deleted at Grantor's expense or accept the exceptions. The title policy shall be in the amount established by a current and accurate appraisal of the Property (see Paragraph 3(c) below). Grantor shall pay the costs for acquisition of the title commitment and standard owner's title policy.

(c) A current and accurate appraisal of the Property prepared by a professional accredited appraiser, to be obtained at Grantor's expense, and approval of the same by the Property Tax Division of the New Mexico Taxation and Revenue Department. Grantor shall pay the costs for preparation of the appraisal; Grantee shall submit the appraisal to the Property Tax Division for review. The appraisal shall provide that the State of New Mexico, Energy, Minerals and Natural Resources Department, State Parks Division may rely on its findings.

(d) A Phase I Environmental Assessment of the Property, to be provided by Grantor at Grantor's expense, submitted to Grantee, stating that the State of New Mexico, Energy, Minerals and Natural Resources Department, State Parks Division may rely on its findings, and verifying that no environmental hazards are located on the Property.

(e) Written proof from Grantor demonstrating that any grazing lease or other form of lease made by Grantor with respect to all or a portion of the Property has been terminated or shall be terminated prior to closing. Grantor shall pay all costs that may be incurred in connection with terminating any such leases.

(f) Construction by Grantor at Grantor's expense of a perimeter fence around the Property that will connect to Grantee's existing perimeter fence for City of Rocks State Park. Grantor shall construct said fence within ninety (90) days of closing in accordance with Grantee's state park fence construction standards.

(g) State Board of Finance approval of Grantee's acquisition of the Property on behalf of the State of New Mexico.

4. Representations and Warranties of Grantor. Grantor represents and warrants to Grantee as follows:

(a) Condemnation. There are no pending condemnation or similar proceedings affecting the Property or any portion thereof, nor has Grantor knowledge that any such action is presently contemplated.

(b) Adverse Information. Grantor has no information or knowledge of any existing violation of any applicable laws, ordinances, or restrictions, or any judicial or administrative action, or any action by adjacent landowners, or natural or artificial conditions upon the Property, which would have a material adverse effect upon the Property or its value.

(c) Pending Litigation. There are no legal actions, suits, or other legal or administrative proceedings pending or threatened against the Property, and Grantor is not aware of any facts which might result in any such action, suit, or other proceeding. There is no proceeding pending or presently being prosecuted for the reduction (or increase) of the assessed valuation of taxes or other imposition payable in respect of any portion of the Property.

5. Title. The Property shall be conveyed to Grantee by general warranty deed, in fee simple absolute, to the "State of New Mexico, Energy, Minerals and Natural Resources Department, State Parks Division," and shall include all appurtenant water rights on the Property. Further, Grantor shall convey any mineral interests it currently holds to the Property. The deed shall be subject to the following permitted encumbrances:

(a) Taxes for the current year, if any, prorated between Grantor and Grantee, to the time of closing;

(b) Those standard printed exceptions listed in NMAC § 13.14.5.9.A that have not been deleted as specified in Paragraph 3(b), above;

(c) Grantor will satisfy any assessments and liens, including but not limited to, all mechanics' and materialmen's liens prior to closing and will indemnify and hold Grantee harmless from any liens filed of record after closing and which may arise out of any claim related to the providing of materials or services to improve the Property as authorized by Grantor or its agents; and

(d) Such other encumbrances as Grantee may choose to accept.

6. Title Insurance. Grantor shall provide an Owners Title Insurance Policy to be paid for as described in Paragraph 3(b) above.

7. General Warranty Deed and Documents of Title. At closing, Grantor shall deliver the executed General Warranty Deed conveying the Property from Grantor to Grantee (as "State of New Mexico, Energy, Minerals and Natural Resources Department, State Parks Division"). Grantee shall take possession of the Property at closing.

8. Closing. The closing of this donation shall be on or before six months after the effective date of the Consent Decree referred to in the second Recital clause of this Agreement, unless otherwise stipulated pursuant to the terms of Paragraph 14 of said Consent Decree and is subject to completion of the contingencies described above in Paragraph 3 prior to closing.

9. Binding on Successors. This Agreement shall extend to and be binding upon the heirs, executors, and administrators, assigns, and successors in interest of the parties hereto.

10. Survival of Representations and Warranties. The representations, covenants, agreements and warranties contained herein shall not be discharged or dissolved with the consummation of this Agreement and shall survive the same.

11. Closing Fees. Grantor agrees to pay the expenses of recording fees and set-up fees, together with all other expenses and costs to be paid by Grantor under this Agreement. Each party shall pay their respective attorneys' fees.

12. Amendment. The parties to this Agreement may, by mutual agreement, amend its terms through a written instrument approved by both parties.

IN WITNESS WHEREOF, the parties hereto have herein below executed this Agreement as of the date of last signature..

GRANTEE: State of New Mexico
Energy, Minerals and Natural Resources Department
State Parks Division

By: _____
Cabinet Secretary or Designee

Date: _____

GRANTOR: Freeport-McMoRan Chino Mines Company.

By: _____
[Title]

Date: _____

TRUSTEE: New Mexico Natural Resources Trustee

By: _____
Trustee

Date: _____

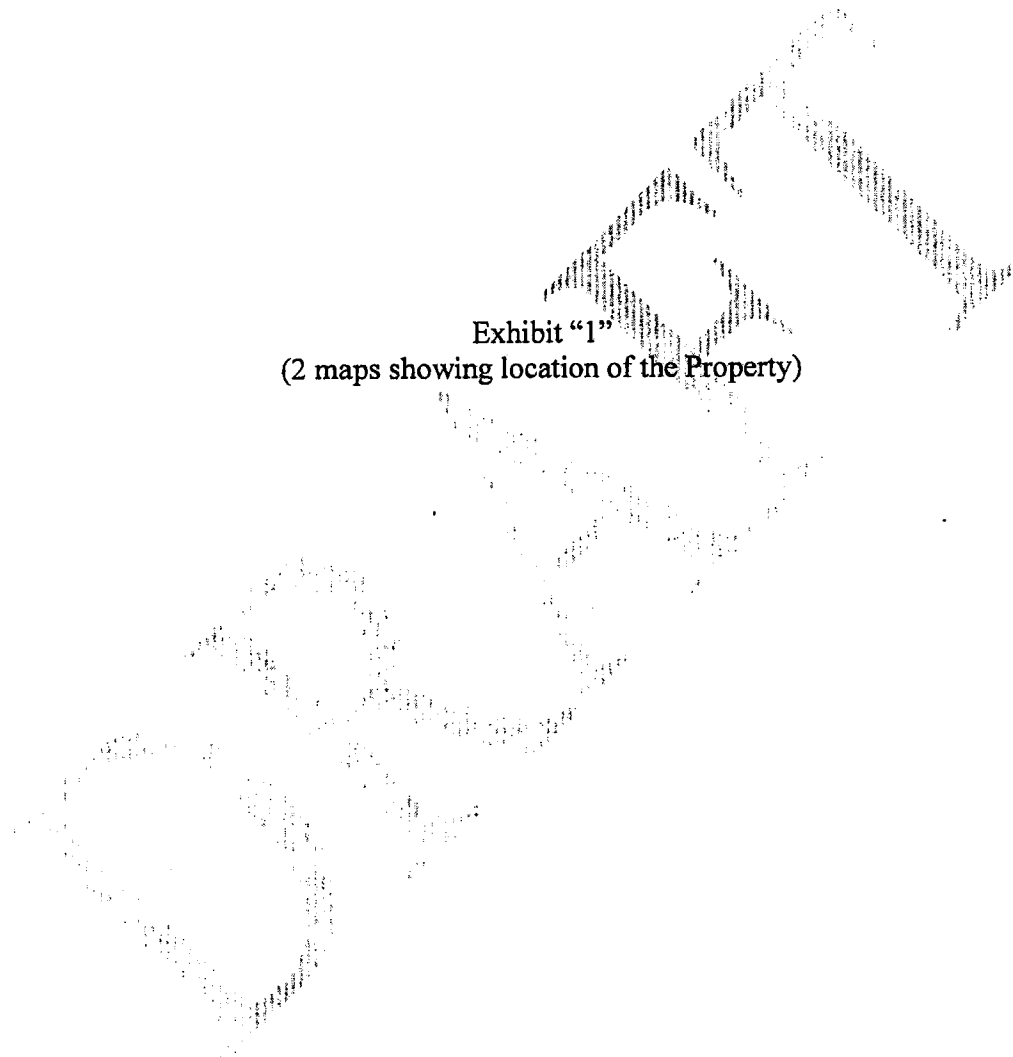

Exhibit "1"
(2 maps showing location of the Property)

REVISED PLAT OF SURVEY OF PROPERTY OF
 CHINO MINES COMPANY WITHIN SECTIONS 9, 10, & 16,
 T20S, R11W, NMPM, GRANT COUNTY, NEW MEXICO

Legal Description - Parcel A

A parcel of land within Sections 9, 10 & 16, T20S, R11W, NMPM, Grant County, New Mexico, being more particularly described as follows:
 Beginning at corner 1, the SE corner of the W1/2SW1/4 and a point on the boundary of the City of Rocks State Park tract, whence the NE corner of the W1/2SW1/4 bears N01°58'22" W (record), a distance of 3532.35 feet;
 Thence along said boundary of the City of Rocks State Park tract S 86°25'20" W, a distance of 1277.54 feet to corner 2, the SW corner of Section 10;
 Thence continuing along said boundary of the City of Rocks State Park tract S 01°52'43" W, a distance of 3205.11 feet to corner 3, the SW corner, also being a point on the easterly right-of-way of the City of Rocks State Park Access Road;
 Thence along said easterly right-of-way N 02°24'08" W, a distance of 2680.94 feet to corner 4;
 Thence continuing along said easterly right-of-way on the arc of a curve to the right, having a central angle of 43°53'32", a radius of 472.95 feet, a length of 352.31 feet, and a chord bearing of N 17°47'21" E, a distance of 353.52 feet to corner 5;
 Thence continuing along said easterly right-of-way N 37°41'22" E, a distance of 1115.76 feet to corner 6;
 Thence continuing along said easterly right-of-way on the arc of a curve to the left, having a central angle of 31°52'51", a radius of 1145.53 feet, a length of 637.82 feet, and a chord bearing of N 22°29'33" E, a distance of 629.43 feet to corner 7;
 Thence continuing along said easterly right-of-way N 07°07'33" E, a distance of 867.07 feet to corner 8;
 Thence continuing along said easterly right-of-way on the arc of a curve to the left, having a central angle of 21°14'19", a radius of 871.72 feet, a length of 322.19 feet, and a chord bearing of N 03°38'40" W a distance of 321.29 feet to corner 9;
 Thence continuing along said easterly right-of-way N 09°47'00" W, a distance of 127.91 feet to corner 10, the NW corner, also being a point on the south boundary of the City of Rocks State Park;
 Thence along said south boundary of the City of Rocks State Park S 89°42'00" E, a distance of 320.38 feet to corner 1, the NE corner, also being the NE corner of the W1/2SW1/4;
 Thence along the east boundary of the City of Rocks State Park S 01°58'22" E, a distance of 2630.85 feet to corner 1, the point of beginning;
 Said parcel contains 43.718 acres, more or less.

Notes:

- (1) Banks of Bearing from Warranty Deed Bk 267 Pp 5687-5688 recorded in the Grant County Clerk's Office.
- (2) Parenthetical values are record values from Warranty Deed Bk 267 Pp 5687-5688 recorded in the Grant County Clerk's Office.

NOTE:

THIS REVISION IS TO CORRECT ADDJINER INFORMATION IN SECTION 21 AS SHOWN ON PLAT OF SURVEY FILED JANUARY 3, 2008 AND ON FILE AT PLAT BOOK 7, PAGE 741 OF THE GRANT COUNTY CLERK'S RECORDS.

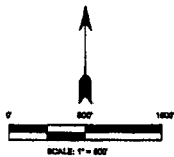

Legal Description - Parcel B

A parcel of land within Sections 9, 10, & 16, T20S, R11W, NMPM, Grant County, New Mexico, being more particularly described as follows:
 Beginning at corner 1, a point on the northerly right-of-way of New Mexico Highway No. 81, whence the BE corner of Section 16 bears S 89°05'39" E, a distance of 1782.34 feet;
 Thence N 09°03'39" W, a distance of 2265.80 feet to corner 2, the SW corner, whence the SW corner of Section 16 bears N 80°05'39" E, a distance of 2265.80 feet to corner 3;
 Thence N 00°04'00" W, a distance of 2905.33 feet to corner 4;
 Thence N 89°49'00" E, a distance of 3482.28 feet to corner 5;
 Thence N 02°18'39" W, a distance of 1743.03 feet to corner 6;
 Thence N 09°11'52" E, a distance of 342.31 feet to corner 7;
 Thence N 24°59'50" E, a distance of 404.20 feet to corner 8;
 Thence N 34°48'30" E, a distance of 1424.82 feet to corner 9;
 Thence N 08°37'39" E, a distance of 825.19 feet to corner 10;
 Thence N 10°11'52" E, a distance of 430.16 feet to corner 10, the NW corner, also being a point on the south boundary of the City of Rocks State Park tract;
 Thence along said south boundary of the City of Rocks State Park tract S 89°42'00" E, a distance of 836.52 feet to corner 11, the NE corner, also being the NE corner of the westerly right-of-way of the City of Rocks State Park Access Road;
 Thence along said westerly right-of-way S 09°47'00" E, a distance of 149.73 feet to corner 12;
 Thence continuing along said westerly right-of-way on the arc of a curve to the right, having a central angle of 21°30'28", a radius of 771.72 feet, a length of 289.75 feet, and a chord bearing of S 03°48'28" E, a distance of 290.50 feet to corner 13;
 Thence continuing along said westerly right-of-way S 07°07'33" W, a distance of 867.44 feet to corner 14;
 Thence continuing along said westerly right-of-way on the arc of a curve to the right, having a central angle of 31°58'33", a radius of 1045.52 feet, a length of 582.10 feet, and a chord bearing of S 22°29'33" W, a distance of 575.58 feet to corner 15;
 Thence continuing along said westerly right-of-way S 37°41'22" W, a distance of 1114.86 feet to corner 16;
 Thence continuing along said westerly right-of-way on the arc of a curve to the left, having a central angle of 43°32'04", a radius of 872.94 feet, a length of 430.34 feet, and a chord bearing of S 17°49'52" W, a distance of 434.58 feet to corner 17;
 Thence continuing along said westerly right-of-way S 02°17'33" E, a distance of 3783.33 feet to corner 18, the SE corner, also being a point on the northerly right-of-way of New Mexico Highway No. 81;
 Thence along said northerly right-of-way on the arc of a curve to the left, having a central angle of 38°01'12", a radius of 2854.79 feet, a length of 1801.01 feet, and a chord bearing of S 63°52'00" W, a distance of 1771.49 feet to corner 18;
 Thence continuing along said westerly right-of-way S 48°59'00" W, a distance of 213.12 feet to corner 1, the point of beginning;
 Said parcel contains 361.049 acres, more or less.

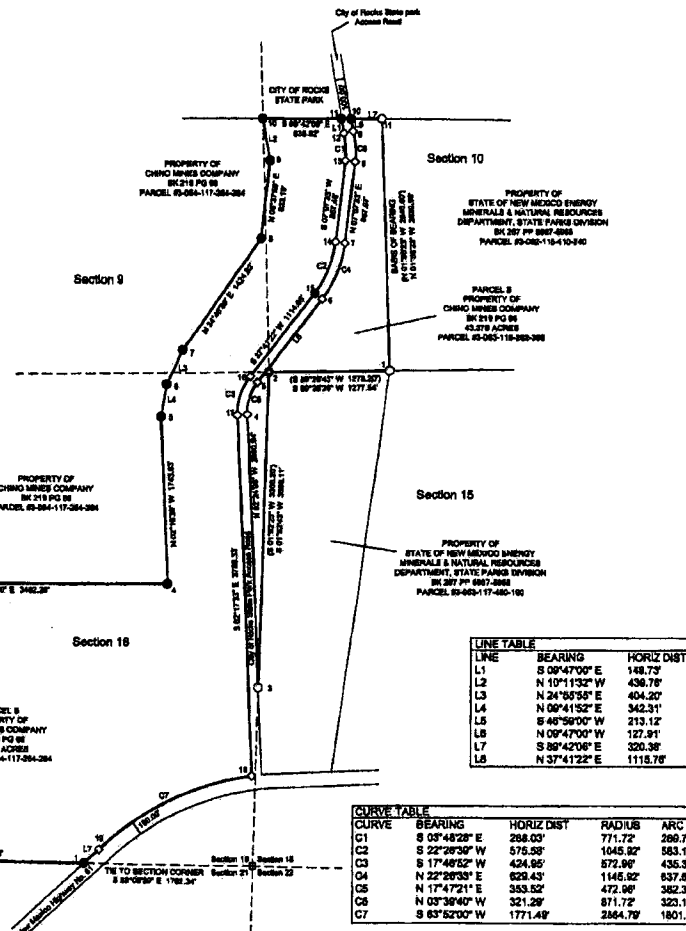

LEGEND

- Found 5/8" Rebar w/ Aluminum Cap Marked "TROUTMAN LS 9435"
- ◇ Found T-Rail Right-Of-Way Marker
- Found 5/8" Rebar with 2.5" Aluminum Cap Marked "SS"
- ⊙ Found Mound of Stone w/ Stone marked "NE 20' and 1/2" Rebar
- Found 5/8" Rebar w/ Plastic Cap Marked "KING SURVEYING LS 7250"
- Set 1/2" Rebar with 2.5" Aluminum Cap Marked "A. ALLRED-SHURE LS 18080"

LINE TABLE

LINE	BEARING	HORIZ DIST
L1	S 09°47'00" E	149.73
L2	N 10°11'52" W	430.16
L3	N 24°59'50" E	404.20
L4	N 09°41'52" E	342.31
L5	S 48°59'00" W	213.12
L6	N 09°47'00" W	127.91
L7	S 89°42'00" E	320.38
L8	N 37°41'22" E	1115.76

CURVE TABLE

CURVE	BEARING	HORIZ DIST	RADIUS	ARC	DELTA
C1	S 03°48'28" E	289.75	771.72	269.73	21°30'28"
C2	S 22°29'33" W	575.58	1045.52	582.10	31°58'33"
C3	S 17°49'52" W	424.95	872.94	430.34	43°32'04"
C4	N 22°29'33" E	629.43	1145.53	637.82	31°52'51"
C5	N 17°47'21" E	353.52	472.95	352.31	43°53'32"
C6	N 03°38'40" W	321.29	871.72	322.19	21°14'19"
C7	S 63°52'00" W	1771.49	2854.79	1801.01	38°01'12"

SURVEYOR'S CERTIFICATE
 I, Amanda J. Allred, New Mexico Professional Surveyor #18080, hereby certify that this Survey Plat and the actual survey on the ground upon which it is based were performed by me or under my direct supervision; that I am responsible for this survey; that this survey meets the Minimum Standards for Surveying in New Mexico; and that it is true and correct to the best of my knowledge and belief. I further certify that this survey is not a land division or a subdivision as defined in the New Mexico Subdivision Act and is a survey of an existing parcel or parcels.

Amanda J. Allred
 Amanda J. Allred, PS #18080
 Survey #00030
 November 30, 2007
 Revised October 7, 2010

ENR119562 B, S. P. 1843 Plan: 1. Surveyed 11/30/07
 This instrument was filed in the Public Records of Grant County, New Mexico on 11/30/07 at 10:30 AM.
 Public County Clerk, Grant County, New Mexico

INDEXING INFORMATION FOR COUNTY CLERK:
 Within Sections 9, 10 & 16, T20S, R11W,
 NMPM, Grant County, New Mexico
 OWNER NAME: Chino Mines Company
 UNIFORM PARCEL CODE NUMBER:
 3-064-117-284-204

TELESTO
 SOLUTIONS INCORPORATED
 LAND SURVEYING
 BOUNDARY CONSTRUCTION STAKING
 MAPPING WATER RIGHTS SURVEYS
 575-538-5620
 1204 FOLEY BL. SUITE A - SHERIDAN, CO. 80429

LAND DIVISION SURVEY OF PROPERTY OF CHINO MINES COMPANY WITHIN SECTION 3, T20S, R11W, NMPM, GRANT COUNTY, NEW MEXICO

LEGAL DESCRIPTION

A parcel of land within Section 3, T20S, R11W, NMPM, Grant County, New Mexico, being more particularly described as follows:
 Beginning at corner 1, the SE corner of the herein described parcel, also being the SE corner of Section 3 and a point on the boundary of the City of Rocks State Park tract, whence the NE corner of Section 3 bears N01°41'00"W (record), a distance of 5277.75 feet;
 Thence along said boundary of the City of Rocks State Park tract S89°43'39"W, a distance of 2663.45 feet to corner 2, the SW corner, and also being a point on the common boundary of Sections 10 and 3;
 Thence continuing along said boundary of the City of Rocks State Park tract N00°43'32"E, a distance of 3259.59 feet to corner 3;
 Thence N00°43'32"E, a distance of 2049.95 feet to corner 4, the NW corner, and also being a point on the North boundary of Section 3, from whence the NW Corner of Section 3 bears N89°30'28"W, a distance of 2790.65 feet;
 Thence along said North boundary of Section 3 S89°30'28"E, a distance of 2441.29 feet to corner 5, the NE corner, also being the NE corner of Section 3 and a point on said boundary of the City of Rocks State Park tract;
 Thence along said boundary of City of Rocks State Park tract S01°41'00"E, a distance of 5277.75 feet to corner 1, the point of beginning;
 Said parcel contains 310.085 acres, more or less.

LEGEND	
○	Found 1/2" Rebar w/ Plastic Cap Marked "KING SURVEYING LS 7250"
⊕	Found Mound of Stone w/ Marked Stone
●	Set 1/2" Rebar w/ Aluminum Cap Marked "A. ALLRED-SNURE LS 18080"
⊙	Found 5/8" Rebar w/ Metal Tag Marked "LS 9435"
⊗	Found 5/8" Rebar w/ Metal Tag Marked "KING LS 7250"

The accompanying Plat and Land Division of a 310.085± acre tract of land being situated in Section 3, T20S, R11W, NMPM, Grant County, New Mexico, drawn hereon and described in the caption of this Plat hereby approved and accepted by the Ordinance Officer of Grant County.

date this 26th day of Dec, 2007

Armando R. Dominguez
 Ordinance Officer
 Exemption # 071226-1

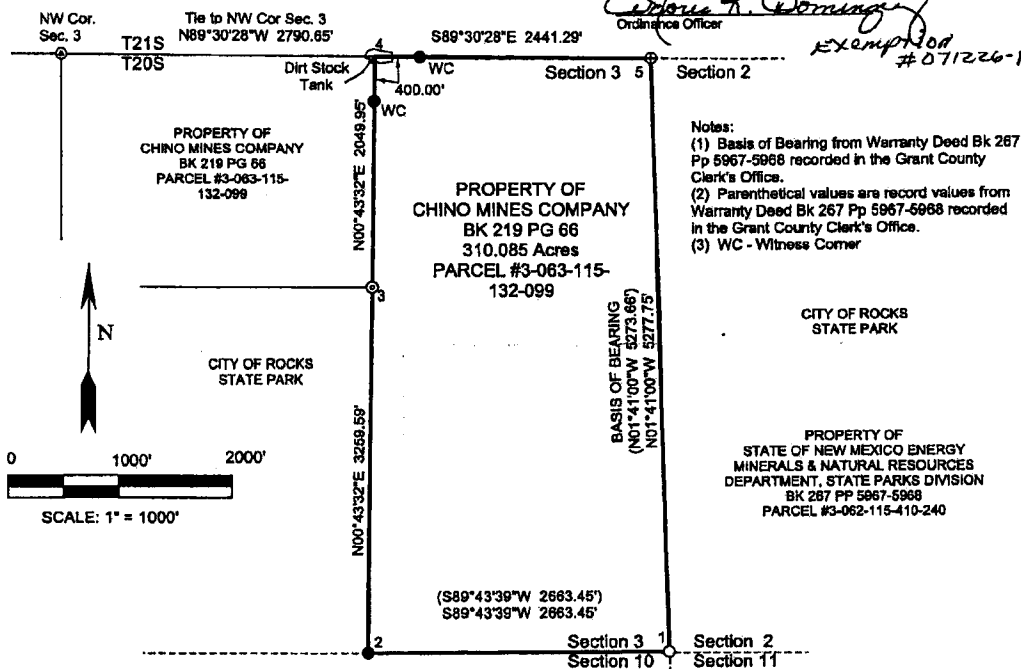

- Notes:
 (1) Basis of Bearing from Warranty Deed Bk 287 Pp 5967-5968 recorded in the Grant County Clerk's Office.
 (2) Parenthetical values are record values from Warranty Deed Bk 287 Pp 5967-5968 recorded in the Grant County Clerk's Office.
 (3) WC - Witness Corner

The Accompanying Plat and Foregoing Land Division of Section 3, T20S, R11W, NMPM, Grant County, New Mexico, as described in the Caption of this Plat, is made with the free consent and in accordance with the desire of the undersigned Agents or Owner and Proprietors of the Land so divided.

Armando R. Dominguez
 Chino Mines Company

State of New Mexico, County of Grant
 The foregoing instrument was acknowledged before me this 15th of Dec, 2007
 My Commission Expires:

March 22, 2008
Mercy R. Leyba
 Notary

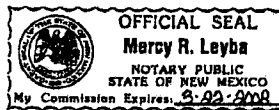

STATE OF NEW MEXICO, GRANT COUNTY
 200800045
 I hereby certify that this instrument was filed for record on 01/03/2008 at 04:02:22 PM & duly recorded in book 7 page 740 Pages 1 of 1
 Witness my hand & seal of office
 HOWIE MORALES, COUNTY CLERK
 DEPUTY - ROBERT

SURVEYOR'S CERTIFICATE

The parcels shown hereon do not constitute a subdivision as defined in the Land Subdivision Ordinance of Grant County, New Mexico and this division of land is being filed under Exemption No. 1, which states:
 (1) The sale, lease, or other conveyance of any parcel that is thirty-five (35) acres or larger in size within any twelve (12) month period, provided that the land has been used primarily and continuously for agricultural purposes, in accordance with NMSA 1978, §7-38-20, for the preceding three (3) years;
 I, Armando J. Allred-Snure, New Mexico Professional Surveyor #18080, hereby certify that this Survey Plat and the actual survey on the ground upon which it is based were performed by me or under my direct supervision; that I am responsible for this survey; that this survey meets the Minimum Standards for Surveying in New Mexico; and that it is true to the best of my knowledge and belief. I further certify that this survey is a land division, but not a subdivision as defined in the New Mexico Subdivision Act.

Armando J. Allred-Snure
 Armando J. Allred-Snure, PS 18080
 Survey 0029
 November 28, 2007
 Phone: (575) 537-8308

TELESTO SOLUTIONS, INC.
 c/o Cobre Mining Company
 303 Fierro Road
 Hanover, NM 88041

